

# Eugene Syriani

Ph.D. Candidate

Supervised by Prof. Hans Vangheluwe

Modelling, Simulation and Design Lab

School of Computer Science

**McGill University**

# MY RESEARCH

## Model Transformation

- Programmed (Controlled) Graph Transformation
- Synchronization + 2-way transformation
- Higher-Order, Hierarchical

## Simulation





- Time: discrete time, real-time
- Parallelism, Distribution



⇒ Aim for an industrially scalable model transformation

**MoTiF**

# MoTiF [2]

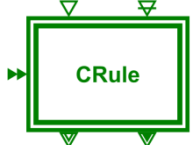
- **AtomicRule (*ARule*)**: transformation rule application 
- **ForAllRule (*FRule*)**: apply on all matches (parallel independent) 
- **TransactionalRule (*XRule*)**: control backtracking enabled 
- **Selector**: At most 1 rule is applied 
- **Synchronizer**: synchronize (merge) “threads” of rule applications 
- **CoupledRule (*CRule*)**: parallel composition of inner models 



# MOTIF: Timed

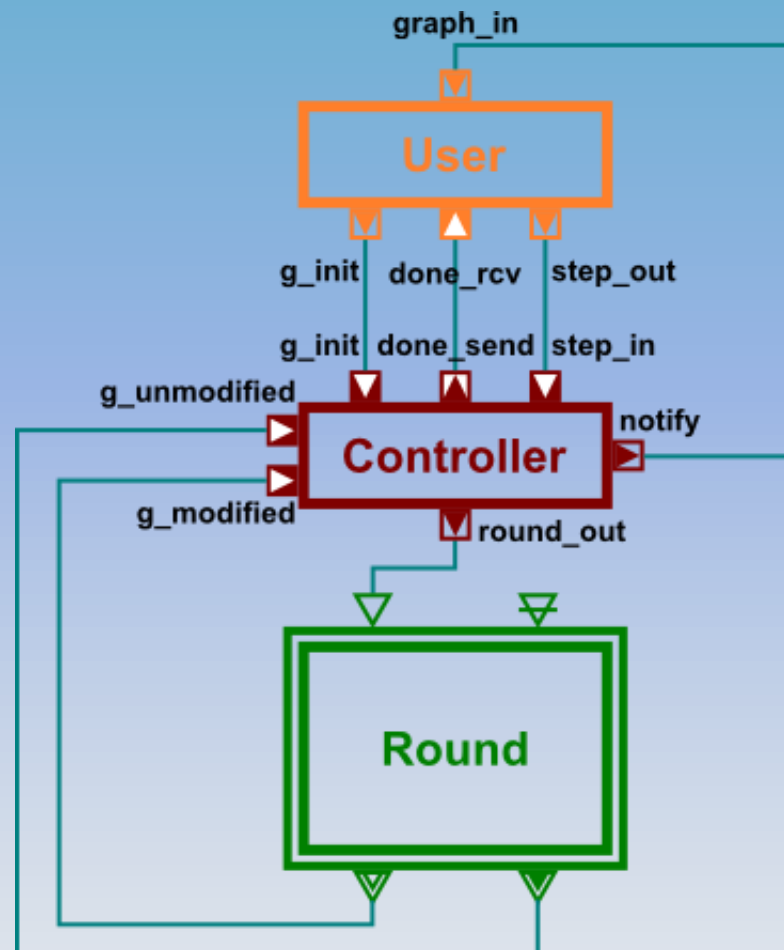

# MOTIF: Modular

- Layers

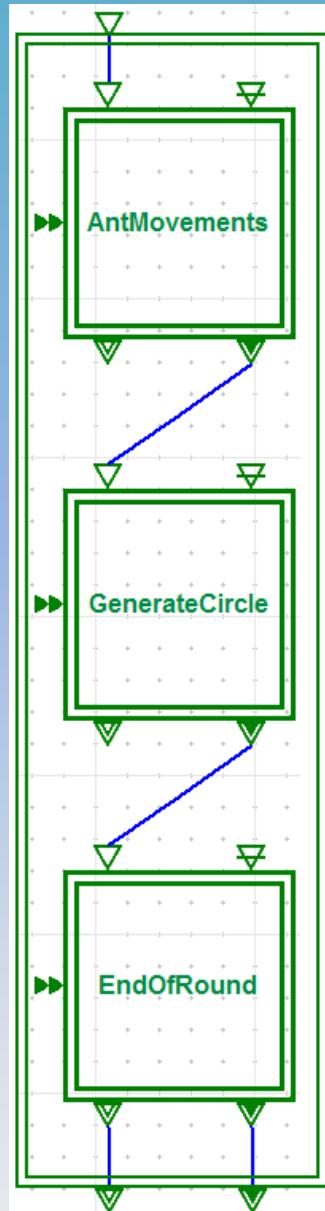

# MOTIF: Transformation

- Patterns

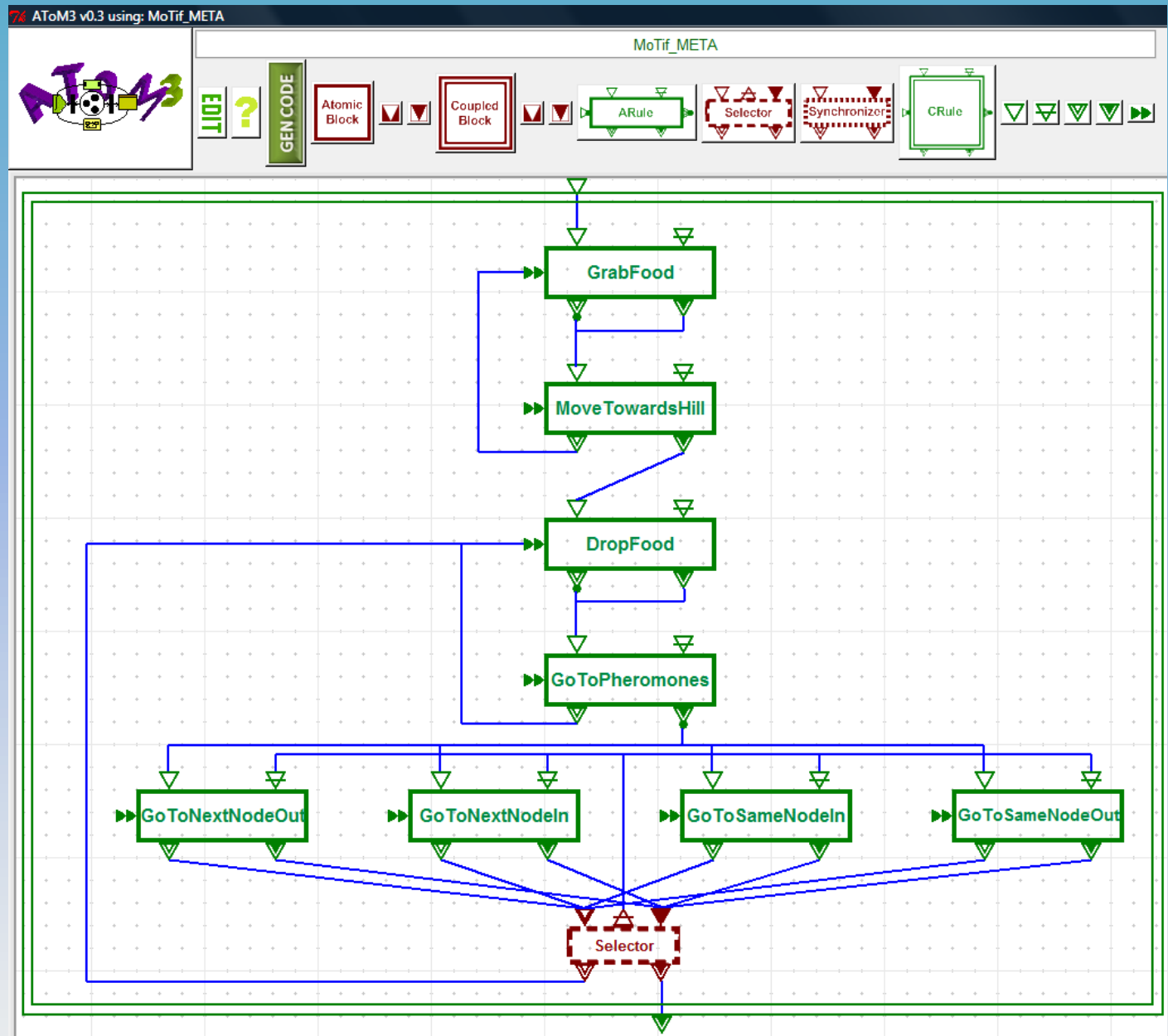

# (MY) INTERESTS IN THIS CAMPAM

- **Scaling of Model Transformation**
  - *Distributability* of transformations
- **Applications**
  - *Applied case-study* for MT
  - *Reduce gap* between existing transformation languages and needs in applications
- **Model Transformation Evolution**
  - Higher-Order transformations (HOT)
- **What would be an optimal meta-meta-model?**